

MECHANICAL ENGRAVING

How to choose your tool?

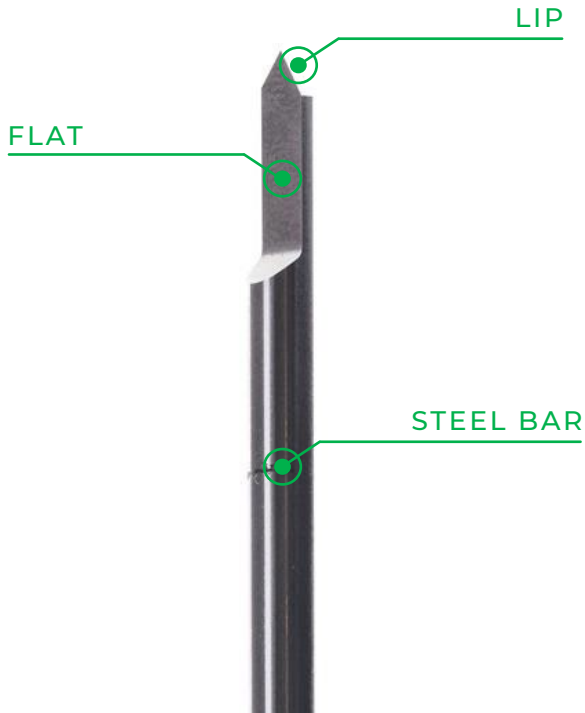

What is an engraving cutter?

Used for engraving and cutting operations on a variety of materials, the cutter is a cutting tool that operates by rapid rotation.

The engraving and cutting stylus consists of:

- a **steel** (or High Speed Steel, HSS) or **carbide** bar cut to length;
- a **flat surface machined** for the required application;
- **cutting lips**, also called teeth.

THE COMPOSITION OF AN ENGRAVING AND CUTTING CUTTER

There are two main types of cutter alloy:

- **Steel cutters** : harder and more resistant to wear, even at high temperatures. They maintain their strength and cutting capacity.
- **Tungsten carbide cutters** : Extremely resistant and durable, they are the most common today. Used for engraving and cutting harder materials.

DIFFERENT CUTTER SHAPES

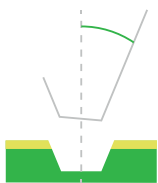

Conical

- Create a V-shaped groove
- Engrave very small characters
- Provide an aesthetic rendering typical of engraving

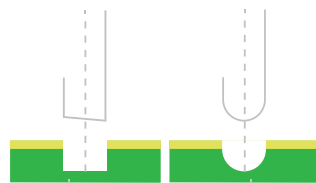

Cylindrical with flat or round end

- Create a groove with straight edges
- Engraving base follows the shape of the tool

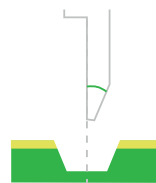

1/4 round

- Create conical grooves
- Highly resistant to hard metal engraving
- Allow good chip clearance

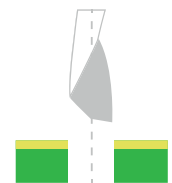

Spirals and helicals

- Dedicated to cutting
- Their spiral profile favors chip evacuation and improves cutting quality while achieving higher speeds



THE NUMBER OF LIPS FOR CUTTING

The more teeth or lips a cutter has, the finer and more even the cut will be. On the other hand, this level of precision impacts the removal of material, which is then longer.

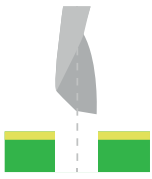

1 lip

Machining aluminum, PVC, acetates, light alloys, grooving non-ferrous materials.

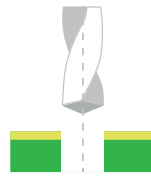

2 lips

Suitable for soft materials (aluminum, brass, plastic).



3 lips

Used for roughing work (rapid removal of large quantities of material).



4 lips

Dedicated to finishing and roughing work thanks to deeper flutes which facilitate good chip clearance.

HOW TO SELECT THE RIGHT CUTTER FOR YOUR PROJECT

Engraving or cutting?

	Engraving (engraving cutters)	Cutting or drilling (cutting cutters)
Cutter shapes	<ul style="list-style-type: none"> • Conical • Cylindrical with flat or round end • ¼ round 	<ul style="list-style-type: none"> • 45° and 15° conical • Spirals and helicals

For which materials?

	two-layer Plastic	two-layer	Acrylic	Soft metals (aluminum or brass)	Hard metals (steel)
Conical	Engraving	Engraving	Engraving	Engraving	-
Cylindrical with flat or round end	Engraving	Engraving	Engraving	Engraving	-
¼ round	-	-	-	Engraving	Engraving
45° and 15° conical	Cutting	Cutting	Cutting	Cutting	-
Spiral and Helical	Drilling	Drilling	Drilling	Drilling	-

For which machine?

	Engraving / Cutting / Drilling	Dragging (Diamond engraving)
M10	-	Twincut
M20* / IM3	Onecut 3.17 mm	
M20 V3 M20 X M40 IS200	Twincut Onecut 4.36 mm	Twincut Onecut 4.36 mm
IS400	Twincut (with collets or high-frequency spindle) Onecut 4.36 mm Onecut 6.35 mm Percut (with collets or high-frequency spindle)	Twincut (with collets or high-frequency spindle) Onecut 4.36 mm Onecut 6.35 mm (with collet spindle)
ISx000	Twincut (with collets or high-frequency spindle) Onecut 6.35 mm Percut (with collets or high-frequency spindle)	Onecut 6.35 mm (with collet spindle) Twincut (with collets or high-frequency spindle)

*M20 are machine versions produced until June 2018. M20 v3 and M20 X are machines produced after this date.

Twincut



The Twincut solution (available in 4.36 mm) is the most **versatile**. The cutters in this range can be used with a **single tool holder**, and are interchangeable.

Onecut



Offers cutters with steel or carbide tips, compatible with near all Gravotech machines.

Percut



Designed to meet **productivity and endurance** requirements. The range offers short tools for applications requiring a collet or high-frequency spindle.

Diamond



Combines delicacy and precision. They are compatible with scratch engraving projects, particularly on metals and glass. The Diamond range is divided into the Onecut and Twincut lines.

TOP 5 MUST-HAVE TOOLS (TWINCUT RANGE)



22.5° Conical

The most versatile for everyday plastic engraving



Conical double cone

The most powerful for metal engraving



30.0° Conical

A tool for detail engraving or fine engravings as in jewelry-making



One lip

For fast, straight cuts



120° Faceted Rotating Diamond

Suitable for scribing glass or metals

Do you need more information?

Contact a Gravotech expert

Distributed by :

GRAVOTECH (SHANGHAI) ENGRAVING EQUIPMENT CO.,LTD.
Building F, No. 1835 Duhui Road,
Minhang District
201108, Shanghai, China

info.cn@gravotech.com
+86 21 24 08 68 88
www.en.gravotech.cn