

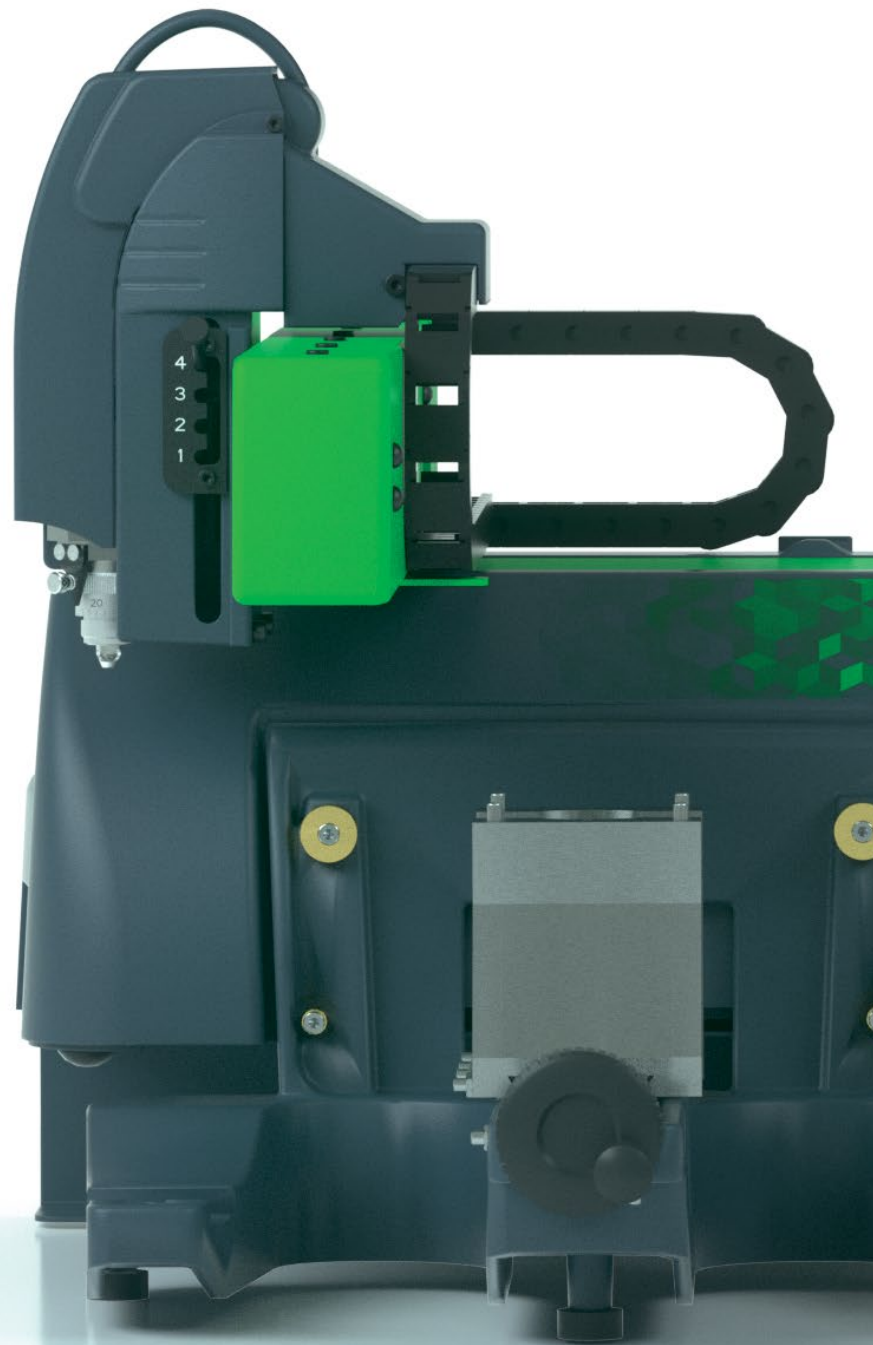

ENGRAVING STATION

M40 / M40 GIFT



GRAVOTECH
EXPRESSION OF THINGS



The M40 is a compact versatile signage engraving machine. Its large engraving area makes it a perfect engraving solution for medium-sized and flat objects. It can engrave a large range of materials such as plastic, glass, wood, metal, and many more!

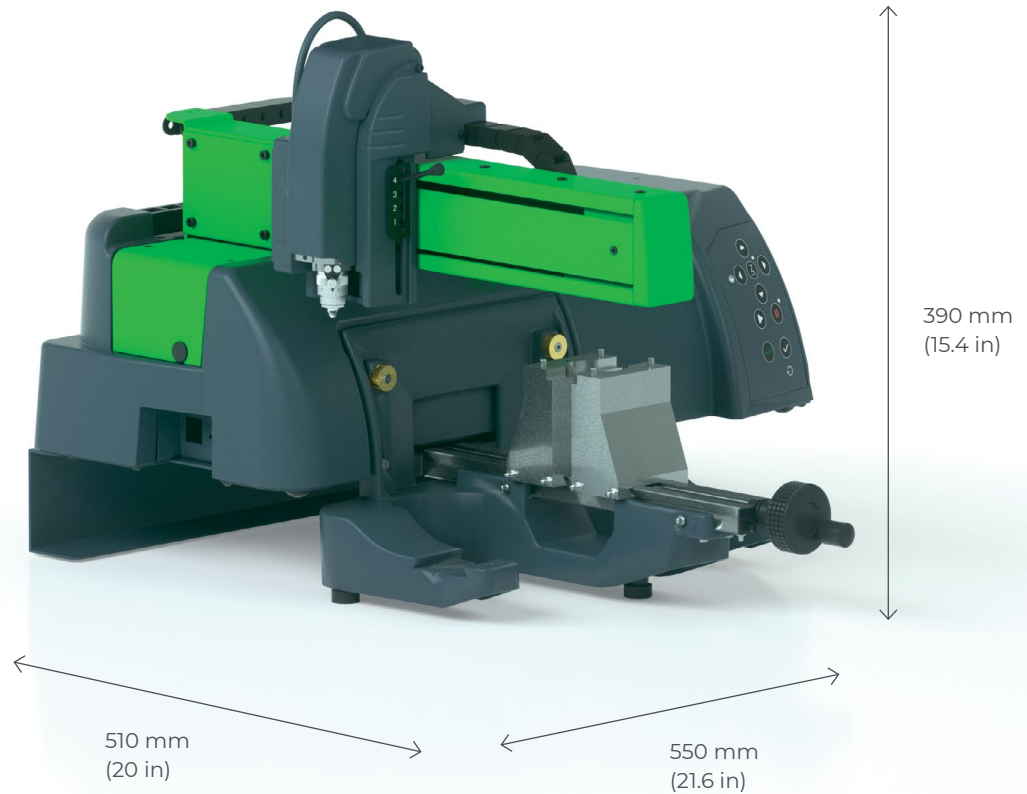

OPEN STRUCTURE

Don't let your machine decide what you can or can't engrave. The M40 210 x 305 mm (8.3 x 12 in) engraving area benefits from an open structure that allows larger items to be engraved when needed. Engrave very long plastic signage plates, electrical labels, thin wood beams, golf clubs, swords, irregular-shape items, and more.

ENGRAVE GLASS WITH THE M40 GIFT VERSION

The M40 Gift includes an automatic lubricant tank and a rotary device to personalize glasses and bottles. The rotary device can be tilted for conical items. Engrave and personalize any flat or cylindrical items up to 110mm height.

ADAPTED FOR BEGINNERS

Control and adjust your work with our dedicated Gravostyle™ or ABC engraving software thanks to several options. The M40 comes with an auto-centering jig and a laser beam (Point & Shoot) to help you place the item to engrave, while the engraving software automatically picks up its position. The included Gravogrip™ table firmly holds the item without leftover residue on it.

SEE OUR VIDEO



KEY FEATURES



Professional Signage

The M40 engraving area matches the professional plate standards (doctor, lawyer, notary plates). It is the perfect plate engraving machine to engrave small and medium-sized plates and signs. Create in-house technical identification plates, electrical labels, operating instructions for appliances, professional plaques and many more.

The engraving software mirror mode allows engraving on the reverse side of acrylic plates, for a clear and professional finish.

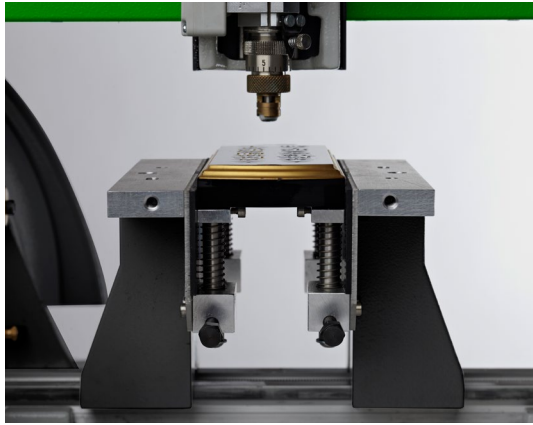

Funeral Market

Create all kinds of funeral signage with your M40 engraving machine.

Engrave wood, plastic, metal, coffin plates, or urns thanks to a cylindrical attachment, personalize commemorative items, add text, figures, and symbols to your composition and more.

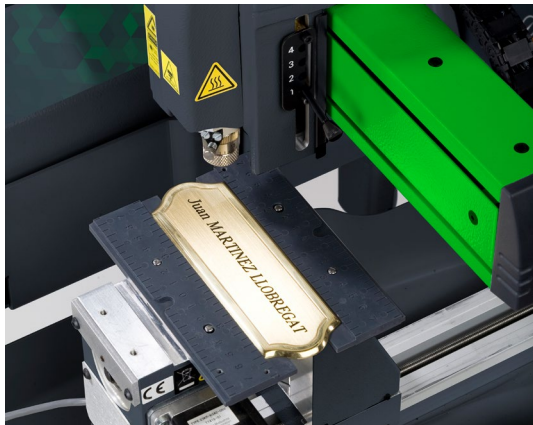

Colored Engraving

Add color to your creation after the engraving. Apply black Gravolaque on plaques for a contrasted result, or personalize your plastic signs with cold wax (several colors available).

Gravotech offers a wide choice of two-layer materials: take off the first layer to see the second one, and get colorful signs without adding any chemical product. Check our consumables catalog to see all the color combinations. Compatible with interior and exterior usage.

LEARN MORE ABOUT THE M40



APPLICATIONS



Funeral plaques and headstones engraving



ID Tags



Marking tools for identification and equipment traceability



Express Engraver



Gift Engraving

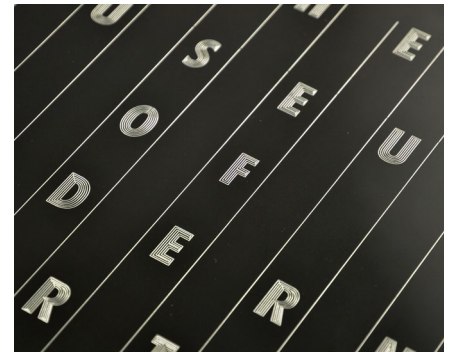

POP displays and sign engraving

MATERIAL CHARACTERISTICS

Technology		ROTARY	SCRIBING/DIAMOND
Materials	Wood, varnished wood	◀▶◻▶	
	Glass, Crystal	▶	
	Leather	◀▶◻	
	Stone, granite, marble	◻▶	
	Food	▶	
	Ceramic	▶	
	Plastics	◀▶◻	▶
	Foam		▶
	Metals	◀▶◻▶	▶

Cutting = ▶ Engraving / Deep marking = ◻ Marking / Etching = ◻

MAKE YOUR SAMPLES



SOFTWARE



ABC Catalog

Do you have a limited range of products to engrave? Catalog is the right choice for you!

Contact us for a customized Catalog version, integrating your own range of products.



ABC

ABC software is the easiest engraving software for Gravotech laser and rotary machines. Engrave in only 3 simple steps, from a computer or a tablet!

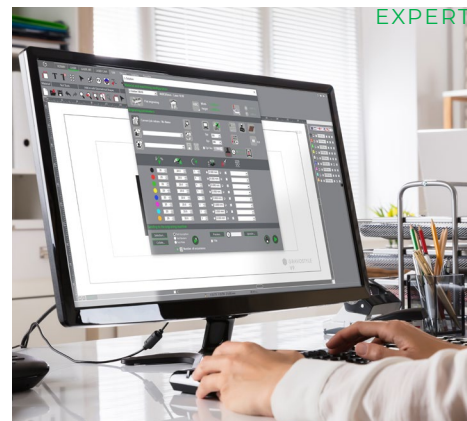

Gravostyle™

One-of-a-kind piloting software for Gravotech laser and rotary engraving machines.

SERVICE & SUPPORT



Training

Our training modules are designed to optimize your use of our solutions and are available for our full range of machines, software and accessories.

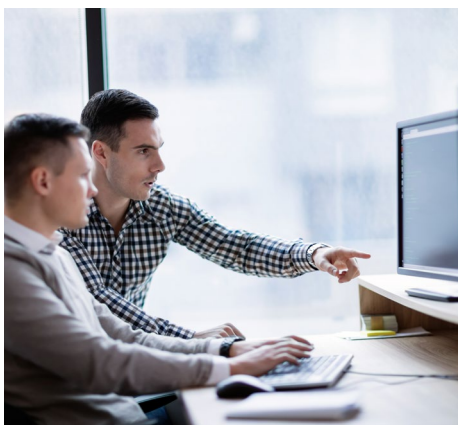

Technical support

We bring you local support in your language in more than 50 countries, where we have established presence directly and with our distribution partners.



Maintenance

Thanks to experience gathered with Gravograph and Technifor and our global presence in more than 50 countries with 150 Gravotech technicians and our distributor partners, we can offer you a wide range of services.

TECHNICAL DATA

	M40	M40 GIFT
Technology	Rotary, scribing	
Marking area max	305 x 210 mm (12 x 8.3 in)	
Max objects size (L x W x H)	Unlimited x 210 x 110 mm (unlimited x 8,3 x 4.3 in)	Unlimited x 210 x 160 mm (unlimited x 8,3 x 6.3 in)
Max objects weight	10 kg (22 lbs)	5 kg (11 lbs)
Spindle power	30 W	
Machine dimensions (L x W x H)	550 x 510 x 390 mm (21.6 x 20 x 15.4 in)	750 x 540 x 570 mm (29.5 x 21.3 x 22.4 in)
Machine weight	19 kg (41.9 lbs)	35 kg (77.2 lbs)
Z axis auto	Yes	Yes
Type of spindle	Top load spindle - Hollow shaft motor	
Noise	< 70 dB	
Point & shoot	Yes	
Operating temperature	min. +5°C (+ 41°F) - max. +40°C (+104 °F)	
Connection to computer	USB / Bluetooth (option)	
Maximum speed	25 mm/s (0,98 in/s)	
Z stroke (Z travel)	40 mm (1,575 in)	
Rotation speed	20 000 rpm	
Tool diameter	4,36mm (0,17 in)	



GRAVOTECH
EXPRESSION OF THINGS

info.cn@gravotech.com

+86 21 24 08 68 88

www.en.gravotech.cn

GRAVOTECH (SHANGHAI) ENGRAVING EQUIPMENT CO.,LTD.

Building F, No. 1835 Duhui Road, Minhang District

201108, Shanghai, China



Follow us: